

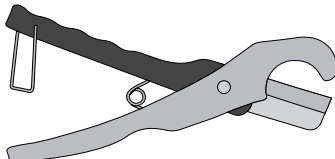



# FLEXIBLE LED BUNDLED PRICING INCLUDES:

\*Available only for qualifying orders

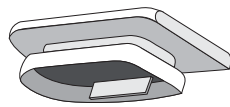
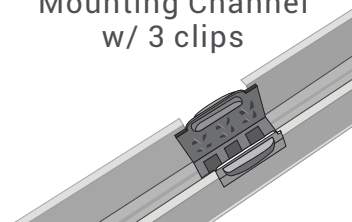
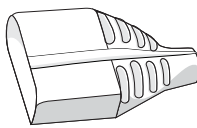
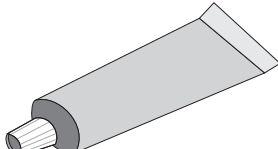

## LumiFlex Installation Materials

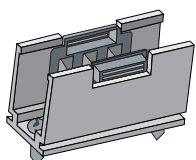
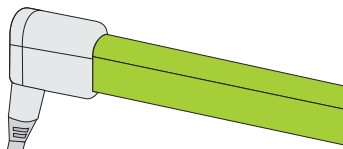
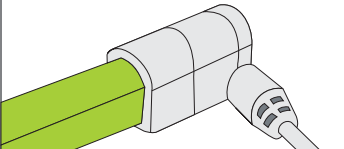
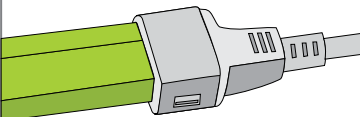
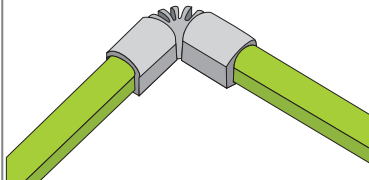
<p><b>700-1035</b> Flexible LED Neon Cutter &amp; File Set</p> 	<p><b>700-1008</b> LumiFlex Interconnect Set <b>Priced Upon Request</b></p> 	<p><b>700-1009</b> LumiFlex Click-In End Cap <b>Priced Upon Request</b></p> 	<p><b>700-1013</b> 36.25" Aluminum Mounting Channel w/ 3 clips</p> 
<p><b>700-1007-S</b> Soldered Input Power Connector Set</p> 	<p><b>700-1016</b> Silicone Adhesive</p> 	<p><b>700-1012</b> Silicone End Cap</p> 	<p><b>700-1010</b> 1-3/8" Aluminum Mounting Clip</p> 
<p><b>700-1014</b> Quick Input Power Connector Set (bottom) <b>Priced Upon Request</b></p> 	<p><b>700-1015</b> Quick Input Power Connector Set (side) <b>Priced Upon Request</b></p> 	<p><b>700-1007</b> Quick Input Power Connector Set (straight) <b>Priced Upon Request</b></p> 	<p><b>700-1013</b> L-Bend Connector Set <b>Priced Upon Request</b></p> 

## Linear Lighting Product

### DETAILS

Input	100-240 VAC
Output	24 VDC
Max. Load Footage	49 ft. (98 ft. with dual power supply configuration)
Watts per Foot	3.10
Dimming Capable	Yes
Bending Parameters	1.97in.
Limited Warranty Terms	5 Years
Materials	Silicone
Dimensions	1.00 x 0.40
Certification	cULus E335482, CE

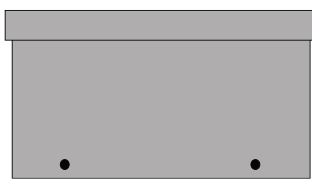
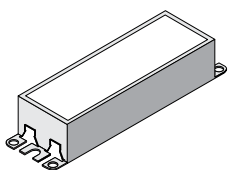
<p><b>185-0154</b> J-Box</p> 	<p><b>HLG-185H-24A</b> Mean Well 185W 24VDC LED Driver</p> 
---	--



**918.622.4978**  
www.lektroninc.com  
sales@lektroninc.com