

RIGID LED
LASER® / LEON®
LED SIMULATED NEON



20L

INSTALLATION GUIDE

MANUAL FOR 64' SYSTEM
POWER SUPPLY
ONLY!

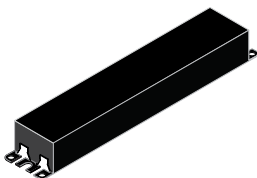

185-2105
96W 24V LOW VOLTAGE
POWER SUPPLY



918.622.4978
www.lektroninc.com
sales@lektroninc.com

Following these few simple steps will ensure a successful installation each time. Remember: No more than 64 boards per power supply.

1. Read ALL instructions, before starting installation.
2. Inspect the boxes for damage and check the parts against the supplied parts list.

NOTE: Report damaged parts or shortages immediately to prevent job slowdown/stoppage to 1-800-634-4059 ext. 0

3. Refer to attached provided print and confirm job measurements.
4. Layout your job on paper, making note of power supply placement.

Power supplies can be placed at the end of runs or side by side to power allowable linear footage in each direction.

NOTE: If job measurements do not correspond to provided drawing, call Lektron Immediately at 1-800-634-4059.

Getting Started, Component Identification & Required Tools

SECTION	PAGE
1. 64 Board Track Mounting Bracket Layout.....	2
2. Installing Track into Mounting Brackets.....	3
3. Custom Cut to Fit End of Runs & Corners.....	4
4. Mounting Track on an Incline.....	5
5. Frame Border Installation.....	6
6. Connecting Power Supplies.....	7
7. Testing Each Section.....	8

COMPONENT IDENTIFICATION & REQUIRED TOOLS

DETAILS











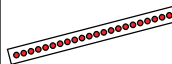
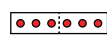

Input.....	120-277 VAC
Output.....	24 VDC
Max. Load Footage.....	64 Lineal ft. 20 Lamp 48 Lineal ft. 30 Lamp & 24 Lamp
Watts per Foot.....	< 1.09 (Varies by Product)
Dimming Capable.....	Yes
Bending Parameters.....	Factory bends available
Limited Warranty Terms.....	5 Years
Materials.....	PVC, UV and impact resistant
Dimensions.....	Laser 1.70 x 1.70, Leon 2.00 x 1.70
Certification.....	cULus E174914

The LEDs come pre-installed in the 20 Lamp LASER® & LEON® System.

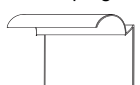
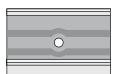
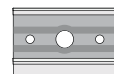
REQUIRED TOOLS:

- 25' Measuring Tape
- 100' Measuring Tape
- Framing Square
- Square - (1')
- Portable Rechargeable Drill
- 5/16" Hexbit and unibit
- Masonry bits (if brick wall)
- Extension Cord
- Sawzall or Compound Saw
- Carpenter Pencil
- Caulk Gun
- Box Knife
- Wire Strippers
- Wire Snips
- Laser Tool or Chalk Line
- Substitute Fasteners for the Application if Applicable

ACCESSORIES:

185-2105 24V 96W Low Voltage Power Supply Class 2 	185-0154 J-Box 	190-5534 J-Box Bracket 	185-0007 PLTC Cable 	20 Lamp 12" LED Boards 	3.25" 6 Lamp Break-Apart LED Board 	185-9005 Laser Rainshield Coupling 	185-0055 Leon Rainshield Coupling 
Mounting Bracket 	Wire Hole Mounting Bracket 	185-5009 #10-16 x 3/4" Tek Screw 	185-5049 #10 x 3" Pan Head Screw 	185-0030 Strain Relief 	185-5023 Blue Wire Nuts 	185-0059 Laser End Cap 	185-0062 Leon End Cap 

LED SPECIFICATIONS

12" LED boards pull close to the same voltage as shorter break-apart boards. Maximum of 3-3" Boards per circuit. No more than 64 boards on a circuit. Do not connect more than one power supply per circuit.

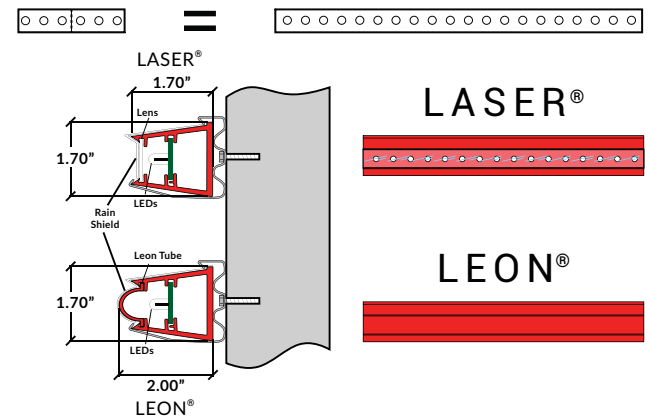

SEC. 1 64 BOARD TRACK MOUNTING BRACKET LAYOUT

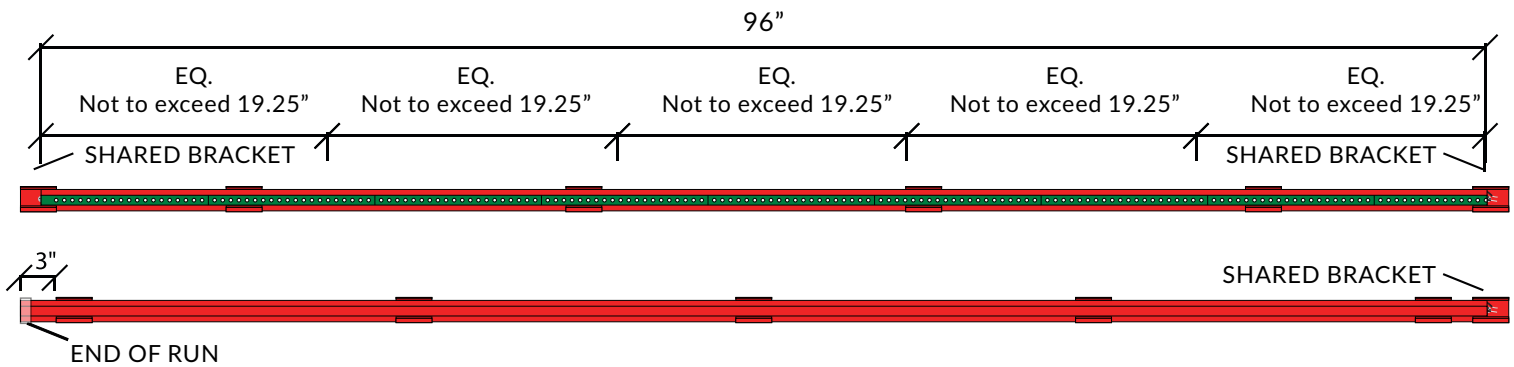

1. Using a chalk line, gauge, laser level, or other means to be certain run is straight, marking locations for brackets.
2. Border / perimeter of sign cabinets should always have orientation of Laser®/Leon® housing raised lip outboard on vertical or diagonal. Orient brackets so that the drain holes will be on the bottom side of the horizontal runs.
3. Install mounting brackets, 6 per 8' section including shared brackets. Use pre-drilled wire hole mounting brackets at power supply locations.

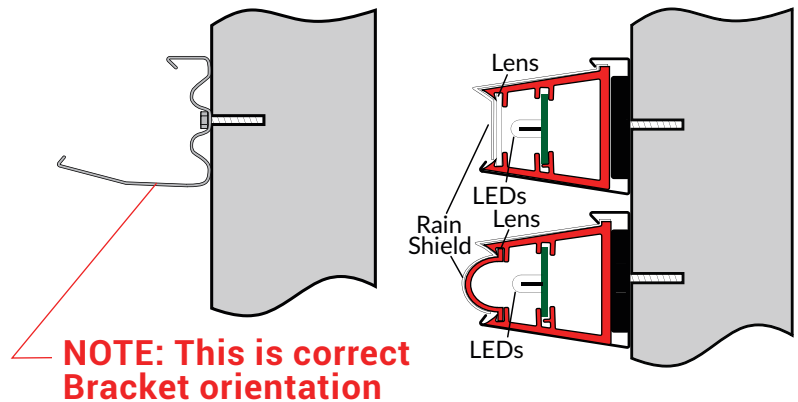

NOTE: Track sections share a bracket at the ends to keep ends together and straight there MUST BE A SPACE left between 8' plastic track sections (NOT LEDs) of 3/16"

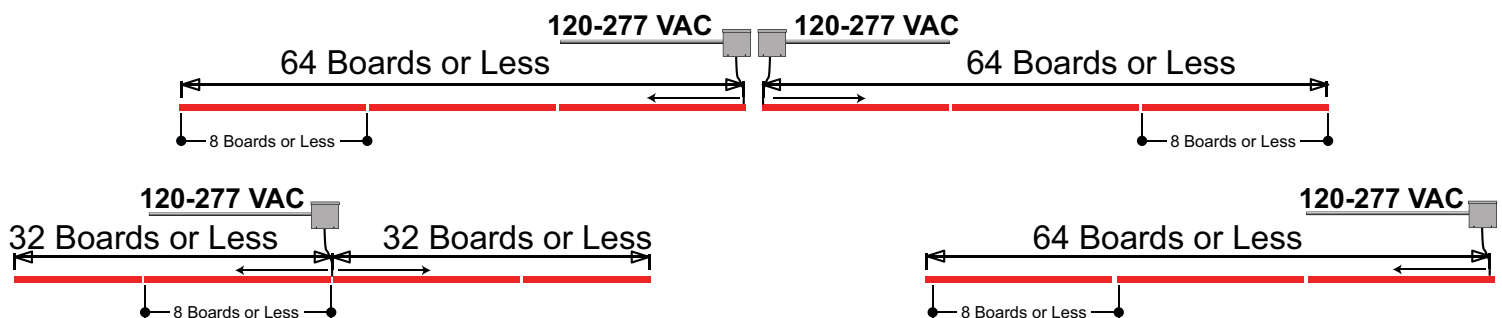

Tip: Install end bracket after housing has been installed into previous brackets by sliding over end to ensure bracket is centered between sections. Place mounting brackets 3" on center from corners.

NOTE: MAXIMUM 64 BOARDS PER POWER SUPPLY. SHOWN 3 CONFIGURATIONS.

SEC. 2 INSTALLING TRACK INTO MOUNTING BRACKETS

1. Connect wires from one section to another using pre-installed molex connectors or wire nut connectors provided.



2. Before hanging sections that have the power cable placed between cut a small notch with dikes or other tool in the back of both housing sections to allow room for cable.



3. Lay the section being added on the mounting brackets. After making wire connections tuck the wires and connectors BEHIND LED circuit boards, Caulk Notch.

4. Insert the top edge into the top bracket latch. Push the track housing in and roll top track housing into mounting bracket bottom point. See diagram top right.

5. Bring sections close together by pushing sections together until LED circuit boards come together but leaving a 3/16" Approx. expansion gap between plastic track sections. Leave no gaps in the LEDs.

6. Install an End Cap at the beginning and end of runs with caulk provided. Caulk on top side only, so water will drain out.

7. Finish by sliding a Coupling Rain Shield under the mounting bracket latch, over both sections. Use a small amount of silicone on one side of rain shield to hold on if necessary.

8. Use a small screw driver to gently pry up the Mounting Bracket Latch to insert Rain Shield under latch making certain it is firmly attached.



3/16" Approx. expansion gap between plastic track sections NOT LEDs.

Coupling Rain Shield

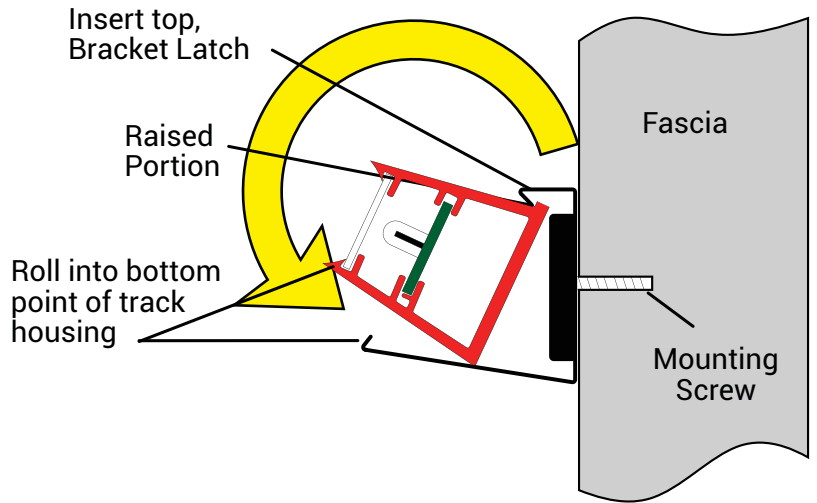

DO NOT HIT LENS TO INSTALL TRACK!
This will permanently damage the lens.

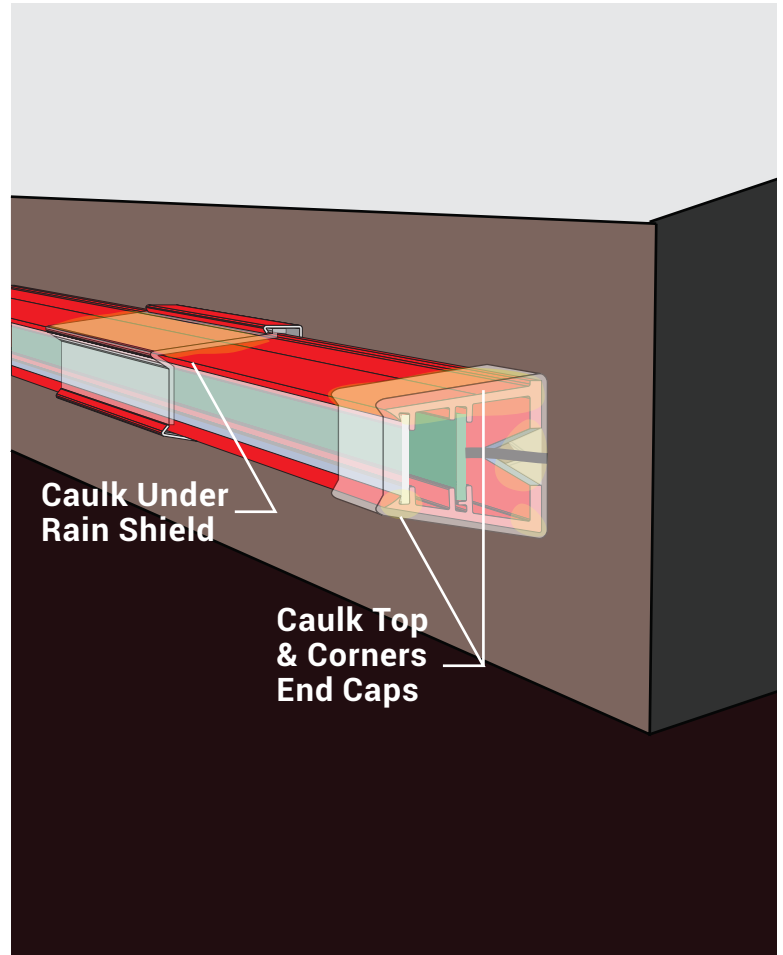

SEC. 3 CUSTOM CUT TO FIT END OF RUNS & CORNERS

END OF A RUN

1. Remove LEDs before cutting the track, by sliding boards out one end.
2. Measure, mark and cut track to required length. Use a fine blade.
3. Add drain holes in the center of the cut piece of track before reinstalling LED using 1/8" drill bit.
4. Reinstall full 12" LED boards until less than 12" of space remains. Make-up remaining space with 3.66" boards.
5. Trim LED light board length at wire connections only. Leave the longest wire length possible.

DO NOT CUT 1 FOOT LED CIRCUIT BOARDS!

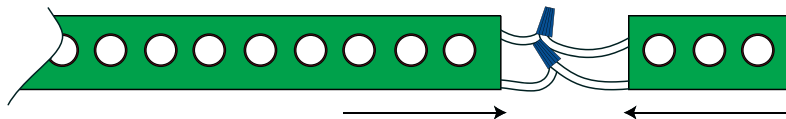

LEAVE NO GAPS BETWEEN BOARDS!

6. Connect 3.66" boards with wire nuts when less than one foot is needed to fill housing with lights. Do not connect more than three of the 3.66" LED light boards together.

NOTE: 3-2/3" boards can be broken in half at the break-line to make a 1-7/8" board. Discard the half that has no wires.

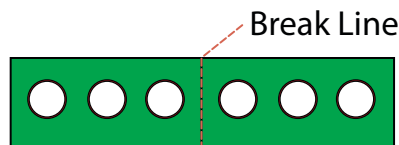

7. Slide LEDs into the Track.
8. Shortened Track is now ready for installation.

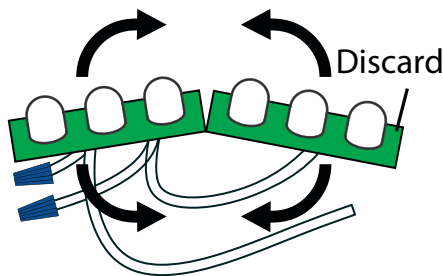

VERY IMPORTANT:

Insulate or remove unused wires at end of run to prevent shorting. Do not connect wires together or to next circuit.

HORIZONTAL CORNERS

Outside Corner

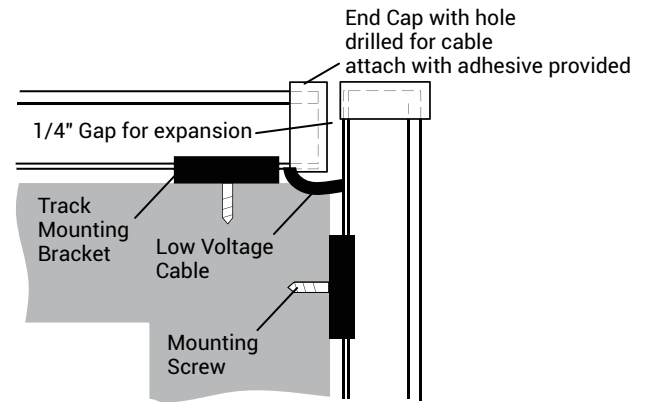

These corners are square cut and overlap slightly to give a continuous look at a distance and allow for thermal expansion.

Inside Corner

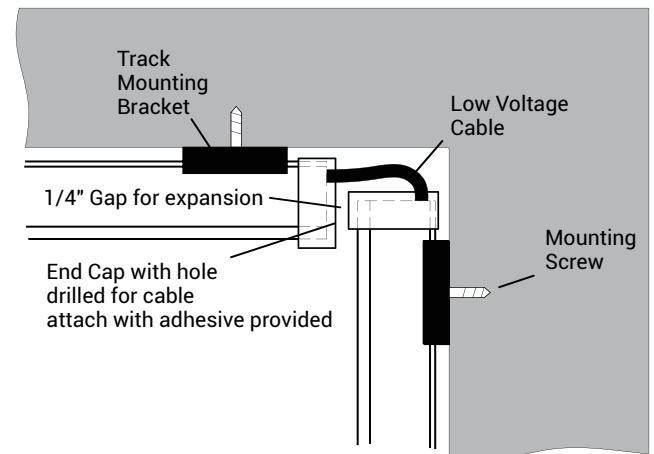

CORNER CONNECTIONS

HINT: THREAD END CAPS ONTO PLTC CABLE BEFORE WIRE CONNECTIONS

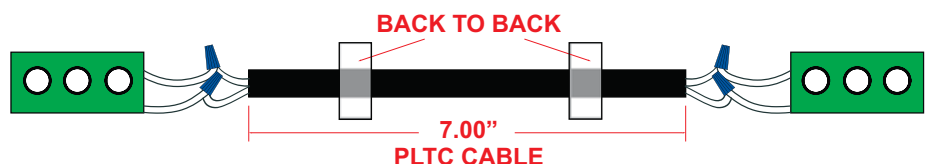

SEC. 4 MOUNTING TRACK ON AN INCLINE

When mounting track on an incline or vertically, two things must be prevented. First, the track must be kept from sliding down, while still allowing for expansion/contraction with temperature changes. Second, water must be sealed out since it will run down the top of the track.

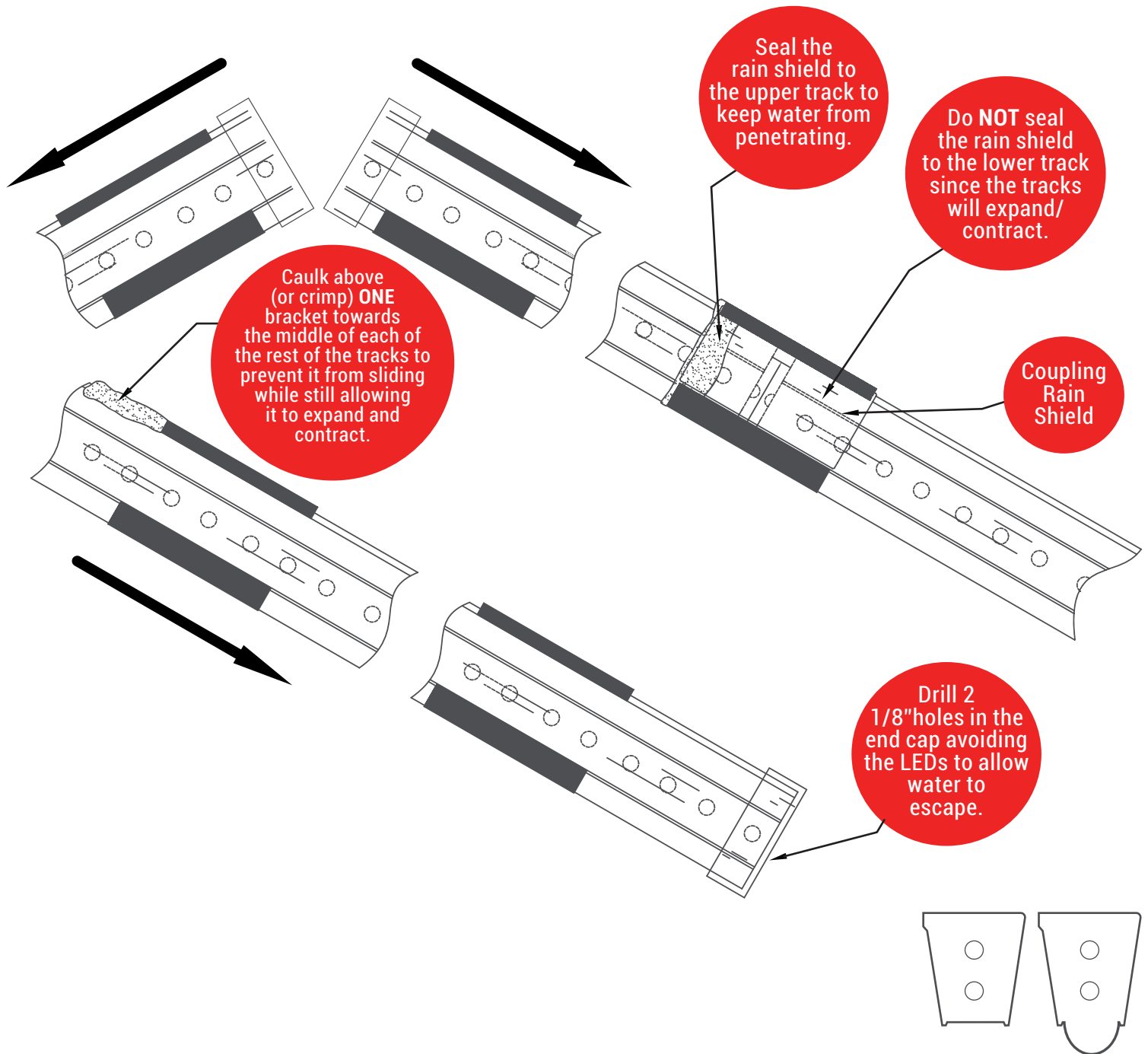

SEC. 5 FRAME BORDER INSTALLATION

Top Left, Top View Detail

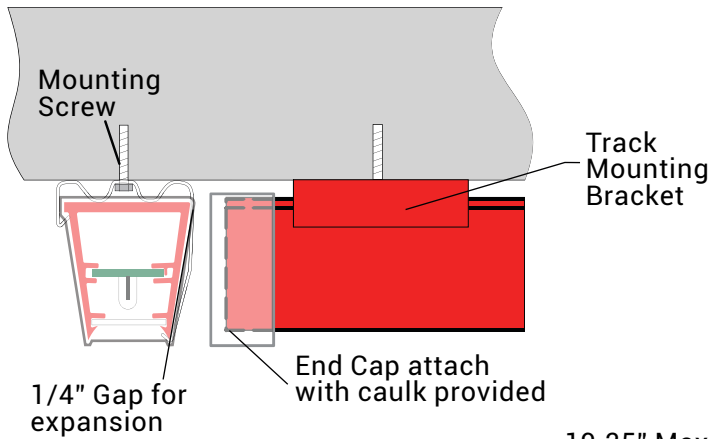

Bottom Right, Side View Detail

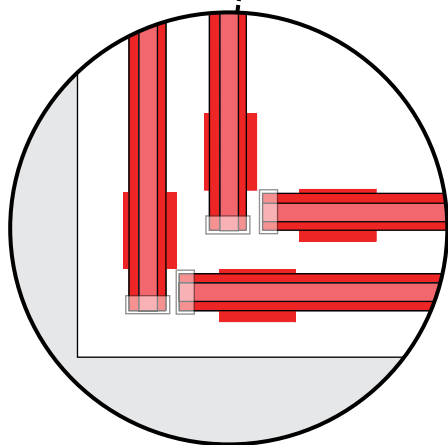
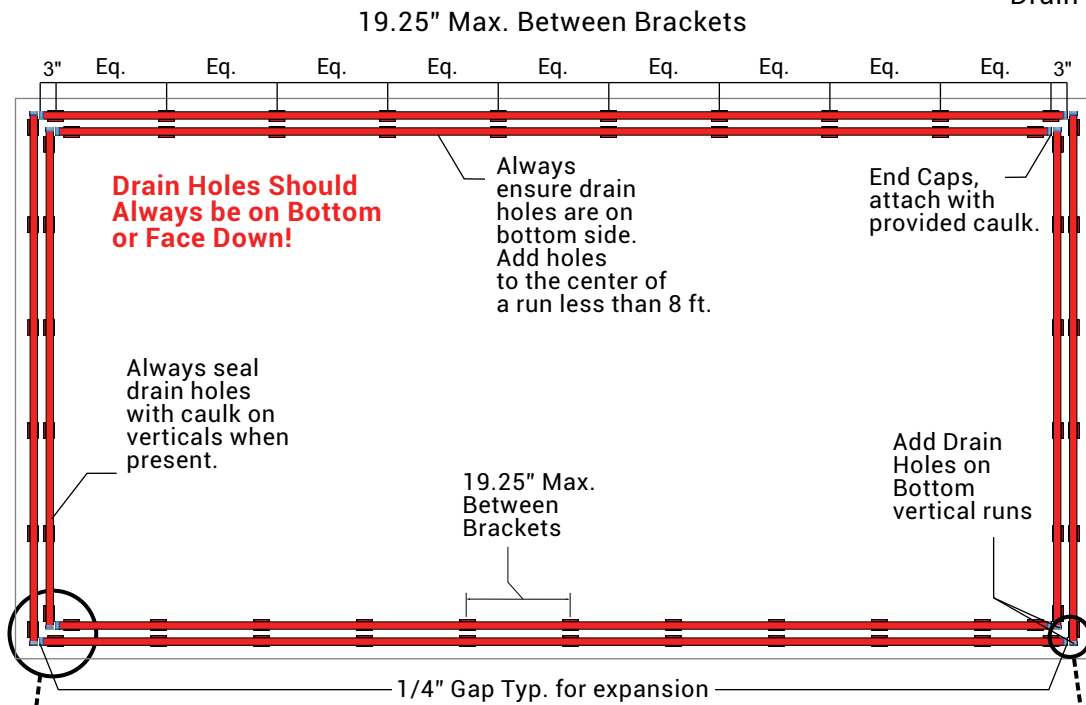
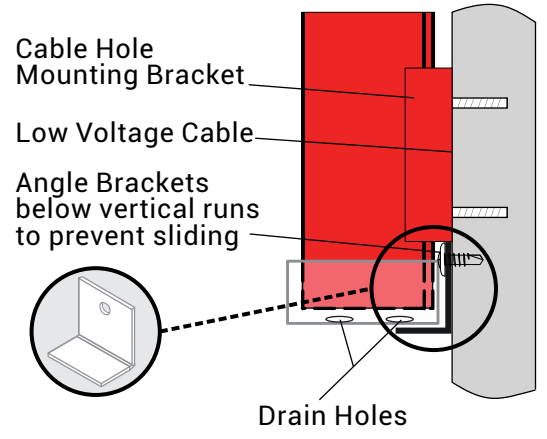

Bottom Left Detail

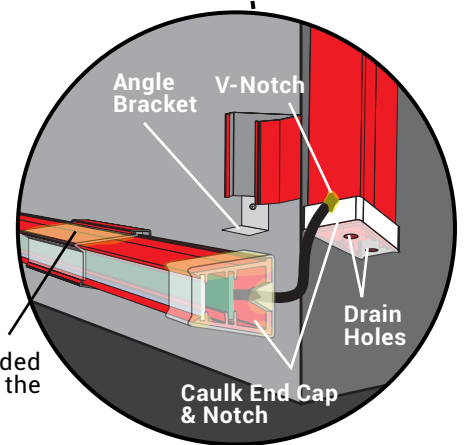

Bottom Right Detail, Profile View

SEC. 6 CONNECTING POWER SUPPLIES



VERY IMPORTANT:
Make sure you are using the correct power supply and LED configuration! Connecting boards to the wrong power supply could result in damage.

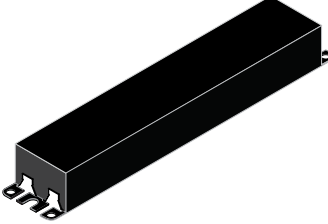

185-2105
96W 24V LOW VOLTAGE
POWER SUPPLY

The LED Configuration is for the 20 Lamp

POWER SUPPLY WIRING

NOTE: Any primary voltage supply greater than 120, "STOP" call Lektron at 918-622-4978

1. Attach J-Boxes with supplied screws to available support member.
2. Attach Power Supplies inside of J-Boxes.
3. Install Strain Relief for low voltage wire.
4. Drill 1/2" hole through the fascia. A conduit fitting can be installed so that conduit can be used.
5. Insert low voltage wire into the hole and connect to LED. Fill hole with silicone sealant.

NOTE: One power supply per 64 boards maximum or less. No less than 8 boards per power supply.

Configuration #1

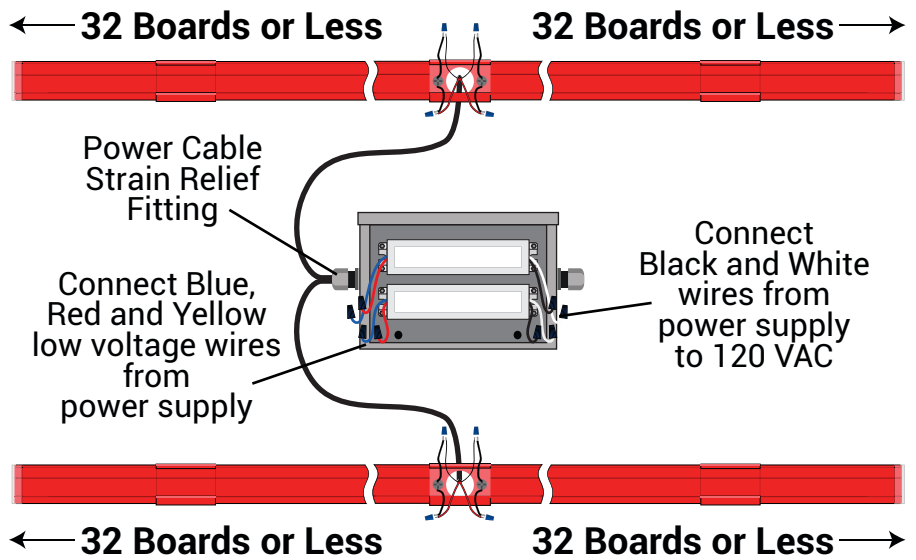

Configuration #2

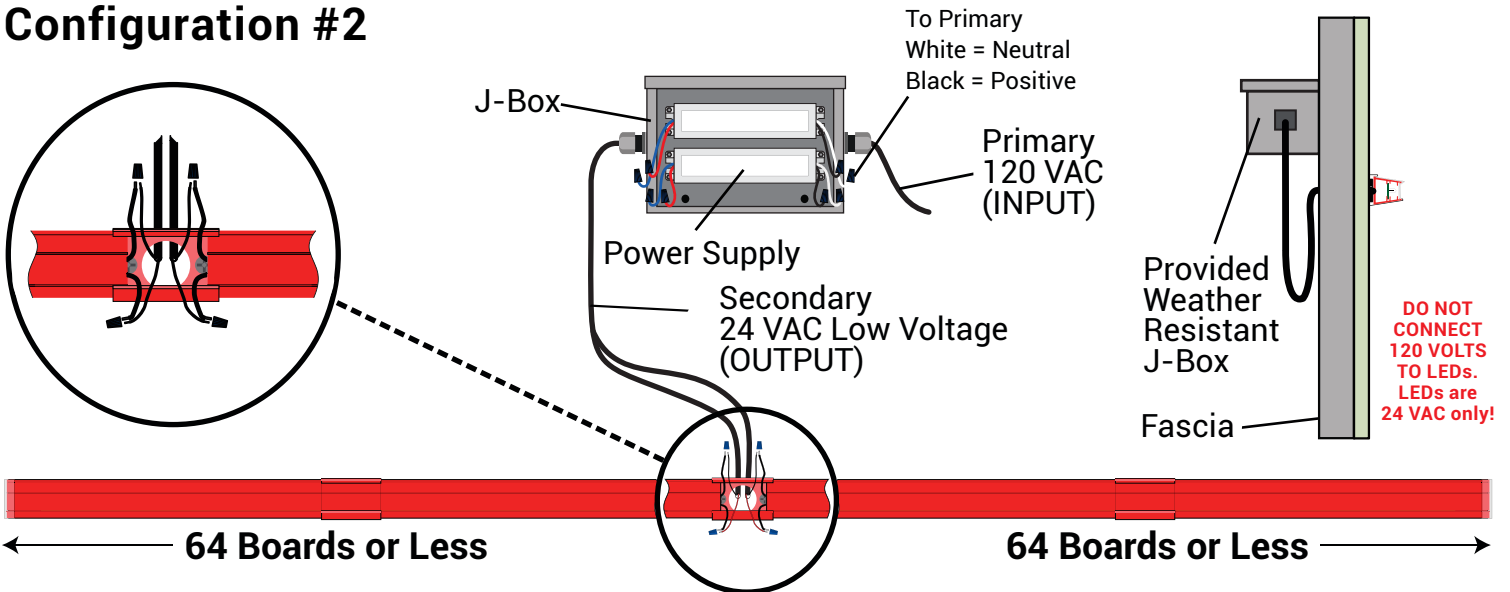

VERY IMPORTANT: KEEP LOW VOLTAGE CIRCUITS ELECTRICALLY SEPARATE, DO NOT CONNECT POWER SUPPLIES OR LEDS FROM DIFFERENT 64 BOARD CIRCUITS TOGETHER OR CONNECT MORE THAN 64 BOARDS TO A POWER SUPPLY!

SEC. 7 TESTING EACH SECTION



IMPORTANT: DO NOT SKIP THIS STEP! ALWAYS CHECK ALL LED LIGHTS BEFORE CONTINUING.

TESTING EACH SECTION

1. Using the installed power supplies, supply power to the LED light chains by connecting a temporary 120V connection to the black and white wires on the power supply to power the LED lights.

REMEMBER: BLACK AND WHITE WIRES ARE FOR 120-277V POWER IN BLUE AND RED ARE FOR LOW-VOLTAGE POWER OUT.

2. Check to see if all LEDs are lit and working correctly.
3. If a board or section does not light up, is damaged, etc., disconnect power and check connections or replace a board by splicing in another.



DO NOT APPLY 120V TO THE BLUE OR RED WIRES OR DIRECTLY TO THE LED LIGHT BOARDS

