

LIGHTBAND
A&W
LED SIMULATED NEON



8.5" BOOMERANG

INSTALLATION GUIDE



918.622.4978
www.lektroninc.com
sales@lektroninc.com

Following these few simple steps will ensure a successful installation each time. Remember: No more than 24 boards per power supply.

1. Read ALL instructions, before starting installation.
2. Inspect the boxes for damage and check the parts against the supplied parts list.

NOTE: Report damaged parts or shortages immediately to prevent job slowdown/stoppage to 1-800-634-4059 ext. 0

3. Refer to attached provided print and confirm job measurements.
4. Layout your job on paper, making note of power supply placement.

Power supplies can be placed at the end of runs or side by side to power allowable linear footage in each direction.

NOTE: If job measurements do not correspond to provided drawing, call Lektron Immediately at 1-800-634-4059.

Getting Started, Component Identification & Required Tools

| SECTION | PAGE |
|--|------|
| 1. Installation of the Housing & LED End of a Run..... | 2 |
| 2. Connecting Power Supply..... | 3 |
| 3. Testing..... | 4 |
| 4. Cutting & Installation of the Lens..... | 5 |

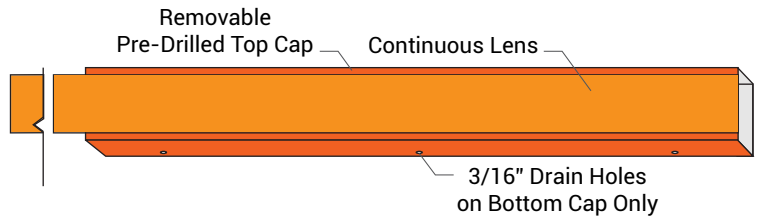

COMPONENT IDENTIFICATION & REQUIRED TOOLS

DETAILS

| | |
|-----------------------------|--|
| Input..... | 120V |
| Output..... | 25 VAC |
| Max. Load Footage..... | 32 Lineal ft. 20L |
| Watts per Foot..... | 1.50 (if 20L) |
| Dimming Capable..... | Yes |
| Bending Parameters..... | None |
| Limited Warranty Terms..... | 7 Years |
| Materials..... | Aluminum Housing Polycarbonate Lens |
| Dimensions..... | Custom |
| Certification..... | cULus E174914 |

LED SPECIFICATIONS



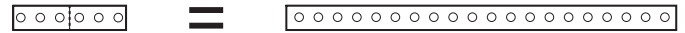







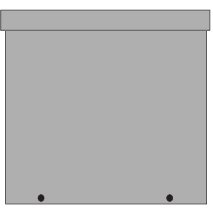



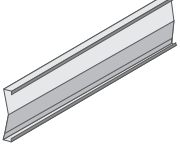
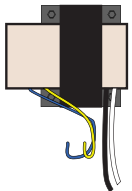

12" LED boards pull close to the same voltage as shorter break-apart boards. Maximum of 3-3" Boards per circuit. No more than 24 boards on a transformer. Site circuit requirements will be determined by total linear footage of product to be installed.

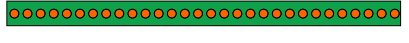

REQUIRED TOOLS

- 25' Measuring Tape
- 100' Measuring Tape
- Framing Square
- Square - (1')
- Portable Rechargeable Drill
- 5/16" Hexbit and unibit
- Masonry bits (if brick wall)
- Extension Cord
- Sawzall or Compound Saw
- Carpenter Pencil
- Caulk Gun
- Box Knife
- Wire Strippers
- Wire Snips
- Laser Tool or Chalk Line
- Substitute Fasteners for the Application if Applicable

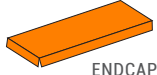
The LEDs come pre-installed in the 8.5" System.

| | | | | | |
|---|---|---|--|---|---|
|  185-2017 J-BOX |  185-0030 STRAIN RELIEF |  185-0005 1/2" PVC LIQUID-TIGHT CONNECTOR |  191-4106 LED MTG CLIP 1.5" |  #12 x 2" HEX HEAD TEK SCREW |  191-6205 HOUSING |
|  185-2006 25V LOW VOLTAGE TRANSFORMER |  185-0007 PLTC CABLE |  185-0006 CONDUIT 1/2" FLEX |  #10-16 x .75" PHIL. MOD. TEK SCREW |  #10-16 x 1" HEX HEAD TEK SCREW |  191-6202 INTERNAL COUPLING RIB SUPPORT |
|  12" 30 LAMP ORANGE MAIN BOARD |  3.25" 8L BREAK-APART BOARD |  185-5023 BLUE WIRE NUT |  185-5021 MALE PIGTAIL CONNECTOR |  185-5022 FEMALE PIGTAIL CONNECTOR |  ENDCAP |
| | | | | |  PRE-DRILLED TOP & BOTTOM CAP |

SEC. 1 INSTALLATION OF THE HOUSING & LED END OF A RUN

INSTALLATION OF THE HOUSING

1. Begin installation with two 8' Housing Sections. Miter cut to meet neatly in the center at required angles.
2. Cut end sections of housings, vertical and parallel to the walls.
3. Remove protective plastic film from the fixture housing.
4. Install sections left or right using #12 x 2 Hex Head screws.
5. Insert couplings into housing section, adjoining housing until it fits snug together. Correct fit is achieved when there is no gap between housings. Hold the seams, attach housing to coupling with #8 x 3/8" Phillips Modified Truss screw into the top and bottom of housing.

DO NOT SKIP THIS STEP, ALIGNMENT IS CRUCIAL TO THE FINISHED PRODUCT

6. Attach housing to the Soffit with supplied Hex Head screws in the flat areas only every 2 ft. top and bottom.
7. Remove LED from housing before cutting last piece to size.

LED END OF A RUN

1. Remove LEDs before cutting the housing
2. Measure, mark and cut housing to required length. Use a fine blade.
3. Reinstall full 1ft. LED boards until less than 1ft. of space remains. Make-up remaining space with 3.25" boards.
4. Trim LED light board length at wire connections only. Leave the longest wire length possible.

DO NOT CUT 1 FOOT LED CIRCUIT BOARDS!

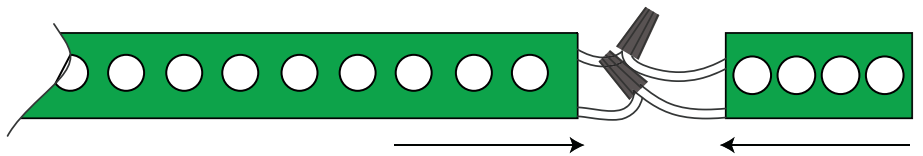

LEAVE NO GAPS BETWEEN BOARDS!

5. Connect 3.25" boards with wire nuts when less than one foot is needed to fill housing with lights. Do not connect more than three of the 3.25" LED light boards together.

NOTE: 3-1/4" boards can be broken in half at the break-line to make a 1-5/8" board. Discard the half that has no wires.

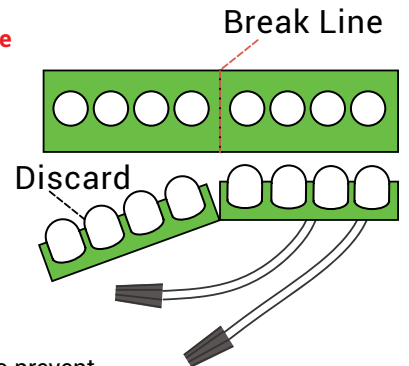

6. Install LEDs into clips.
7. Shortened track is now ready for installation.

VERY IMPORTANT:

Insulate or remove unused wires at end of run to prevent shorting. Do not connect wires together or to next circuit.

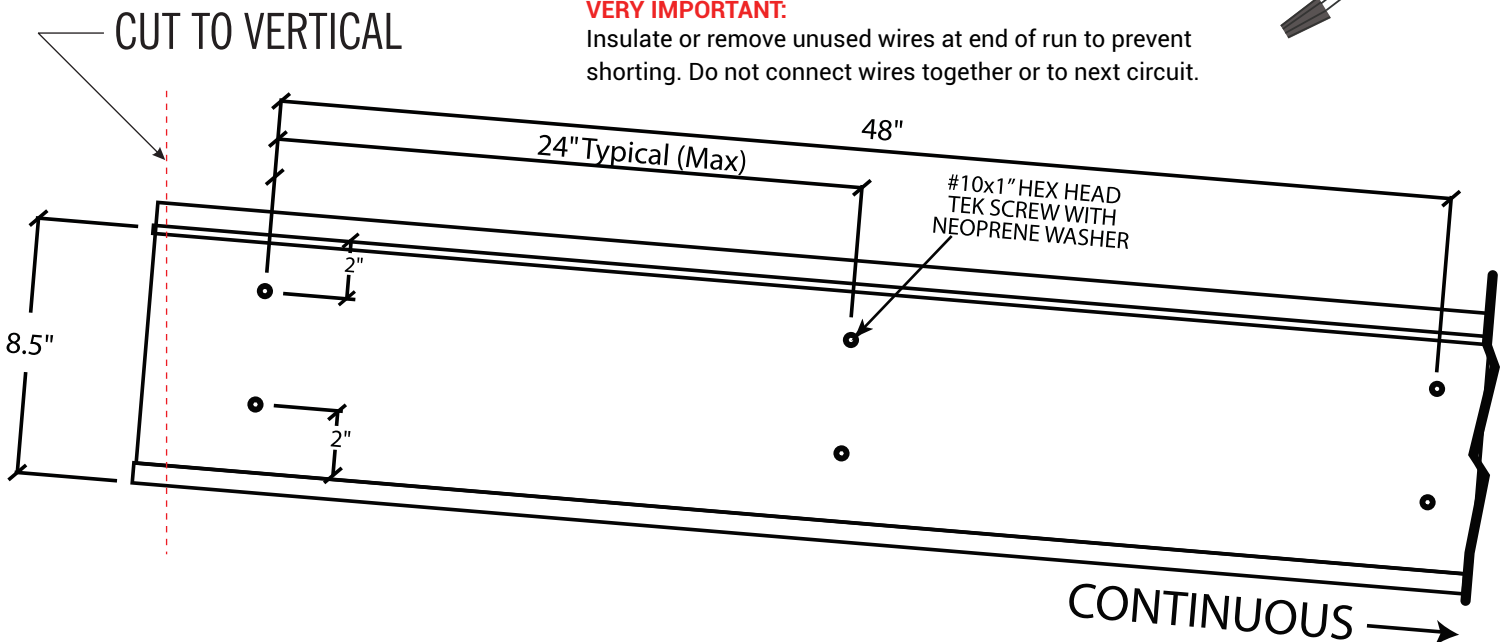

SEC. 2 CONNECTING POWER SUPPLY

NO MORE THAN 24' OF LED BOARDS PER POWER SUPPLY

For additional information please call LEKTRON Inc, 800-634-4059

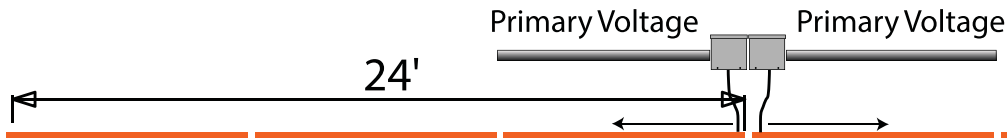

8.5" Boomerang

30 Lamp Powers
Single Row 24' TOP

Side by Side GANG mounting location shown below, when necessary can reduce primary and secondary wiring labor time.

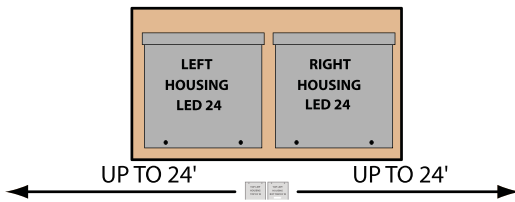

1. Cut crate lid down to a 36" x 18" rectangle. Space J-Boxes approximately 2" apart. This may vary depending on gang size.
2. Attach J-Boxes with supplied screws.
3. Attach LV transformers to back of J-Boxes.
4. Install strain reliefs for LV wire exiting through J-Box and into LED box.
5. Install entire assembly into ceiling void with fasteners to wall.
6. Drill 1/2" hole at the top and bottom inside of housing through the fascia.
7. Insert low voltage wire into the hole and connect to LED. Fill exterior penetration hole with silicone sealant.

PROVIDED WEATHER RESISTANT ELECTRICAL J-BOX

SECURE ELECTRICAL BOX SCREWS PROVIDED OR OTHER SUITABLE ANCHORS. MOUNT AS CLOSE AS POSSIBLE TO LEDS TO MINIMIZE LOW VOLTAGE POWER CABLE LENGTH. INSTALL POWER TRANSFORMER INSIDE ELECTRICAL BOX AND ATTACH WITH 3/4" SCREW.

Blue and Yellow low voltage wires from power supply. Connect to low voltage cable (Non-polarized)

Power Cable from Power Supply FOR CONNECTING LOW VOLTAGE POWER SUPPLY ONLY

Power cables for circuits shown passing a single mounting bracket with a hole drilled for cable access. A conduit fitting can be installed so that conduit can be used. It is not necessary to connect power at end of circuit, transformer low voltage power cable can also be connected at any point in LED circuit boards.

.55A PRIMARY LOAD/power supply

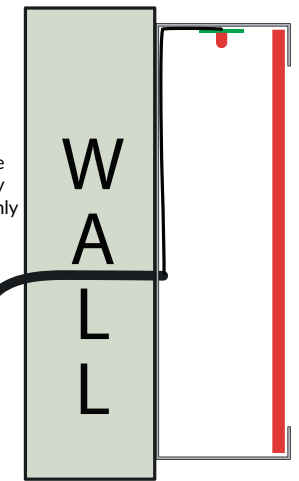
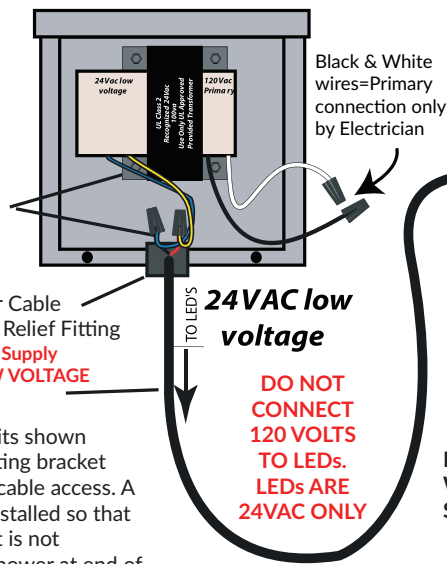

DRILL HOLE AND FEED WIRE THROUGH. USE SILICONE TO SEAL HOLE.

Customer's qualified electrician to make all final primary connections to each J-Box

SEC. 3 TESTING



IMPORTANT: DO NOT SKIP THIS STEP! ALWAYS CHECK ALL LED LIGHTS BEFORE CONTINUING.

TESTING EACH SECTION

1. Using the installed power supplies, supply power to the LED light chains by connecting a temporary 120V connection to the black and white wires on the power supply to power the LED lights.

REMEMBER: BLACK AND WHITE WIRES ARE FOR 120-277V POWER IN BLUE AND RED ARE FOR LOW-VOLTAGE POWER OUT.

2. Check to see if all LEDs are lit and working correctly.
3. If a board or section does not light up, is damaged, etc., disconnect power and check connections or replace a board by splicing in another.



DO NOT APPLY 120V TO THE BLUE OR RED WIRES OR DIRECTLY TO THE LED LIGHT BOARDS

SEC. 4 CUTTING & INSTALLATION OF THE LENS

LENS INSTALLATION

1. Make sure UV side is up. Leave protective film on.
2. Check lens angles first before marking and cutting lens.
3. Mark cut lines on the lens film.
4. Cut Boomerang V-Lens to correct fit.
5. Remove protective film from the lens, and set into the bottom guide.
6. Install Top Cap to hold lens in place
7. Seal all top cap joints with a small amount of silicone.

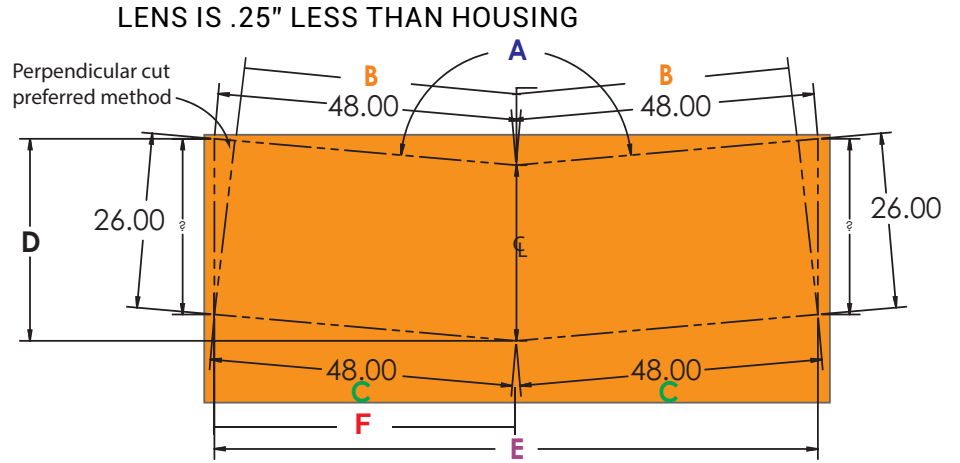

IMPORTANT: DO NOT CUT ORANGE LENS TOO SHORT. MAKE SURE YOUR MEASUREMENT IS CORRECT. MAKE SURE YOUR ANGLE IS CORRECT. THE ORANGE LENS CANNOT HAVE MANY SPLICES AND CANNOT BE REPAIRED ONCE IT IS CUT.

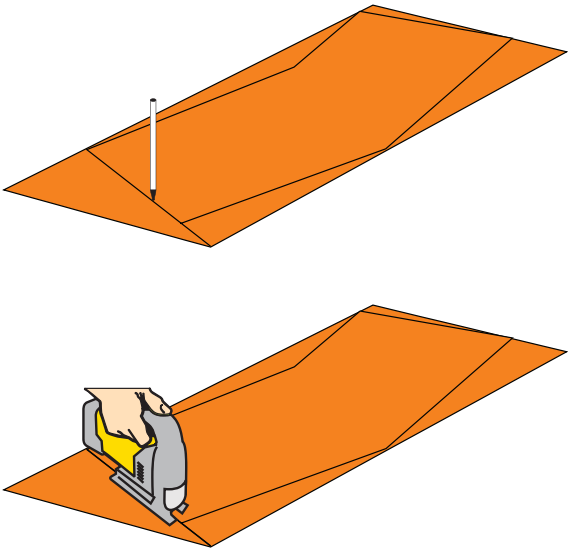

ONE PIECE LENS! NO CENTER SEAM.

DO NOT USE BOOMERANG COUPLING OVER THE LENS!



